

# McDaniel

## General Service Gauges (Heavy Duty • Brass Internals)

### Polyamid 'B' Case      4" and 6" Gauges (Fiberglass reinforced)

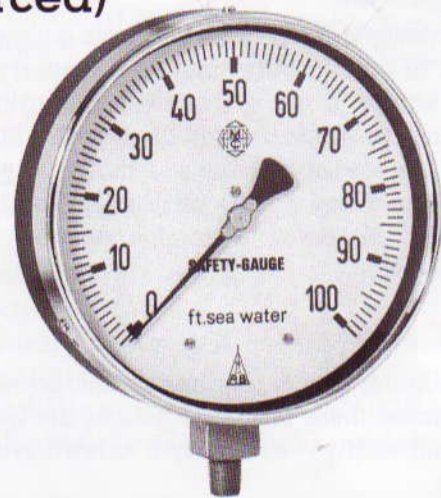
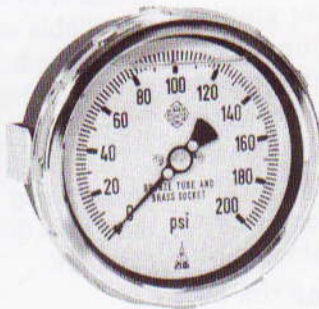
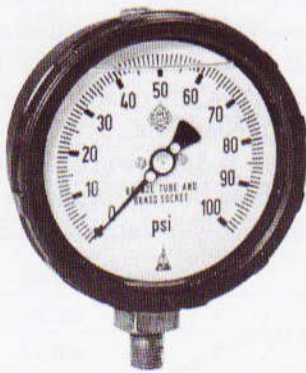

### Stainless Steel Case 2 1/2" Gauges



### All Brass 2 1/2" Gauges



# McDaniel General Service Gauges

## Brass Internals

McDaniel designs and manufactures a wide variety of gauges for almost every type of service and/or application.

The models in this catalog combine the cost advantage of brass internals with the proven ruggedness and accuracy of McDaniel engineering.

The selections include:

- **Polyamid 'B'** Case gauges reinforced with fiberglass in 4" and 6" models;
- **304 Stainless Steel** case gauges in durable 2½" models;
- **All Brass** gauges with heavy-duty die-cast solid brass cases in 2½" models.

## Safe and Reliable

McDaniel designs and manufactures its gauges to minimize failure and to protect personnel and property. The use of laminated safety glass, rather than plexiglass or single strength glass, prevents dangerous pressure build-up in the case; the glass breaks at pressures that vary with the glass diameter. The glass cracks uniformly and the laminate remains intact. Moreover, the laminated glass won't craze or discolor in service.

## Repair Feature

If any McDaniel gauge requires repair, down-time can be minimal because these McDaniel gauges are field-repairable – quickly and easily – with only a screwdriver needed for disassembly.

If circumstances permit and factory repair is preferred, we will make that repair at a nominal service charge. See "WARRANTY & REPAIR / REFURBISHED" for further details.

## Pulse/Vibration Protection

McDaniel offers liquid-filled gauges for applications involving vibration and/or pulsation. Glycerin is an excellent damper of bourdon tube movement. Emersion of the entire measuring assembly in a protective liquid envelope provides lubrication and shuts out corrosive or dirty atmospheres – thereby minimizing wear of moving parts and prolonging gauge life significantly.

## Choice of Filling

When you order a McDaniel fillable gauge you may choose to fill it yourself or you may order it factory-filled with the liquid of your choice. Thus, you can minimize inventory cost.

Glycerin filling has a lower operating temperature limit 32°F (0°C) undiluted. The mixture of water\* in proportions up to 35% will lower the limit commensurately to – 40°F (-40°C) (we recommend distilled water).

The maximum temperature limit is not determined by the fluid but by the gauge's synthetic gasket. At elevated temperatures the gasket may bake and lose its elasticity.

When ordering a gauge to be factory-filled, specify **GF** for Glycerin Filled, **SF** for Silicone Filled or **FF** for Fluorolube Filled.

**Warning:** Glycerin filled gauges should not be used in applications involving strong oxidizing agents such as chlorine, nitric acid or hydrogen peroxide. (Refer to ASME B40.1)

## Bourdon Tube

McDaniel General Service gauges incorporate phosphor bronze or brass bourdon tubes with precision brass movements for reliable service. Spiral bourdon tubes are used for pressure ranges from 1,000 psi and above in poly 'B' gauges, and from 800 psi and above in the other general service gauges. Above 800 psi are of 316 stainless steel.

The spiral tubes reduce work hardening at elevated pressures by spreading the higher degree of stress over more than 1,000 degrees of coil, thereby minimizing the possibilities of failure.



# (Heavy Duty • Brass Internals)

## Polyamid 'B' Gauges

### Features

- Fiberglass reinforced case
- Blowout relief grommet
- Laminated safety glass lens
- No pointer stop on dial
- Adjustable pointer
- Quality construction
- Watertight case
- Brass/bronze Bourdon tube (alloy steel over 800 psi)
- Brass movement
- Pulsation dampened (restrictor screw)
- Accuracy: 1/2% full scale ASME B40.1-Grade 2A

### Case Styles

#### 4" (100 mm) Non-Fillable

Model L - 1/4" NPT

Model M - 1/2" NPT

#### 4" (100 mm) Filled or Fillable

Model N - 1/4" NPT

Model P - 1/2" NPT

#### 6" (160 mm) Non-Fillable

Model Y - 1/4" NPT

Model Z - 1/2" NPT

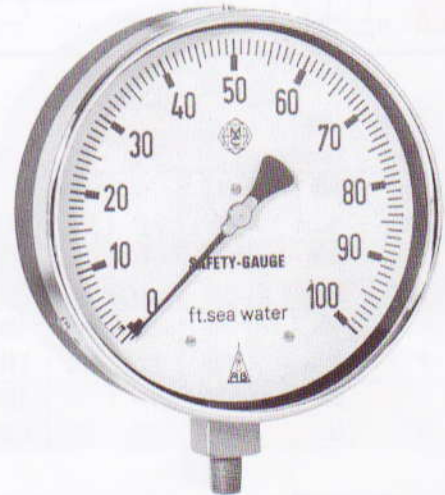

**Ranges:** Vacuum, Receiver, Compound, up to 0-35,000 psi and from 6"wc up to 250"wc, as well as feet of water and feet of sea water ranges.

**Mounting Styles:** Bottom connection. Other configurations available: P, L, U, R and S (see Mounting Style Code).

### Warranty

McDaniel warrants our pressure gauges to be free of defects in material and workmanship. Replacement of any defective gauge will be made at no cost to the purchaser. Gauge failures determined to be caused by abuse, over-range and incompatibility with environment or process media will not be considered under this warranty.

### Repair / Refurbish

We will repair any regular stock McDaniel gauge for a cost of \$15.00 on 4" and 6" sizes; \$7.50 on 2 1/2" and smaller (excluding Utility Gauges). Damaged sockets or bourdon tubes cannot be repaired. (Special Units, contact McDaniel for pricing) Prices are F.O.B. Boute, Louisiana 70039 U.S.A.

### Mounting Style Code

Code	Description
P	Panel mount/lower back connection Models J, L, M, N, P, Y, Z
L	Center back connection (without panel mount flange) Models U
L	Lower back connection (without panel mount flange) Models J, L, M, N, P, Y, Z
U	Panel mount/lower back u-clamp Models J, L, M, N, P, Y, Z
U	Panel mount/center back u-clamp Model U
R	Rear flange for wall-mounting Models J, L, M, N, P, Y, Z
S	Solid front/blow-out back (Fillable; not available with back connection) Models N, P (Stainless Steel Internals)



**Center Back  
(L)**

## Stainless Steel Case Gauges

2 1/2" (63 mm) Fillable

Model J - 1/4" NPT (1/8" NPT, BSP threads, 7/16SAE, available)

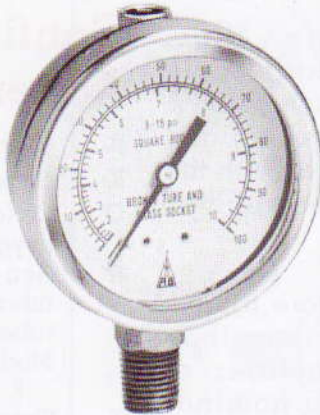

### Features

- 304 Stainless steel case and bayonet ring
- Blowout relief grommet
- Fillable case
- Laminated safety glass lens
- Pulsation dampened with restrictor screw (removable)
- Brass/bronze wetted parts
- Accuracy: 1% full scale ASME B40.1-Grade A

**Ranges:** Vacuum, Receiver, Compound, up to 0-6,000 psi

**Mounting Styles:** Bottom Connection, (L) Lower back (\* Center Back available by special order), (P) Panel, (U) U-Clamp, (R) Rear Flange

## All Brass Gauges

2 1/2" (63 mm) Fillable

Model U - 1/4" NPT (1/8" NPT, BSP threads, 7/16SAE, available)

### Features

- Heavy duty construction
- Blowout relief grommet
- Screwed front ring
- Pulsation dampened with restrictor screw (removable)
- Laminated safety glass lens
- Fillable case
- One piece die-cast case & stem
- Accuracy: 1% full scale ASME B40.1 - Grade A

**Ranges:** Vacuum, Receiver, Compound, up to 0 - 10,000 psi

**Mounting Styles:** Bottom Connection, (L) Center Back, (U) U-Clamp



## Choice of Mounting Styles

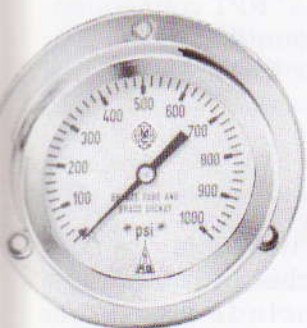

Panel Mount  
(P)



Lower Back  
(L)

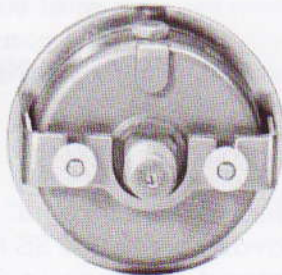

U-Clamp  
(U)



Rear Flange  
Bottom or lower Back Connection  
(R)



## Range Selection \*

Range Code	Range (psi)	Availability (✓) by gauge model			
		L,M Y,Z	N,P	J	U
3	0-3	✓		✓	
5	0-5	✓		✓	
6	0-6	✓			
10	0-10	✓		✓	
A	0-15	✓	✓	✓	✓
B	0-30	✓	✓	✓	✓
C	0-60	✓	✓	✓	✓
D	0-100	✓	✓	✓	✓
E	0-160	✓	✓	✓	✓
F	0-200	✓	✓	✓	✓
G	0-300	✓	✓	✓	✓
H	0-400	✓	✓	✓	✓
I	0-600	✓	✓	✓	✓
J	0-800	✓	✓	✓	✓
K	0-1,000	✓	✓	✓	✓
L	0-1,500	✓	✓	✓	✓
M	0-2,000	✓	✓	✓	✓
N	0-3,000	✓	✓	✓	✓
4k	0-4,000			✓	✓
O	0-5,000	✓	✓	✓	✓
6k	0-6,000	✓	✓	✓	✓
P	0-10,000	✓	✓		✓
Q	0-15,000	✓	✓		
R	0-20,000	✓	✓		
30k	0-30,000	✓	✓		
35k	0-35,000	✓	✓		
S	30"Hg-0 Vacuum	✓	✓	✓	✓
T	Receiver 3-15* psi	✓	✓	✓	✓
U	Compound 30"Hg-0-15 psi	✓	✓	✓	✓
V	Compound 30"Hg-0-30 psi	✓	✓	✓	✓
W	Compound 30"Hg-0-60 psi	✓	✓	✓	✓
X	Compound 30"Hg-0-100 psi	✓	✓	✓	✓
Y	Compound 30"Hg-0-160 psi	✓	✓	✓	✓
2k	Compound 30"Hg-0-200 psi	✓	✓	✓	✓
Z	Compound 30"Hg-0-300 psi	✓	✓	✓	✓

6" wc to 250" wc available. To order wc, mercury or other pressure calibrations, describe the desired range (rather than use a range code) after specifying the code for the model (Inches of H<sub>2</sub>O ranges: standard case is 304 SS) (See Gauge Model Selection Guide for low pressure ranges).

\* Receiver gauge is dual range  
(0-100% primary, 0-10 square root secondary)

## Choice of Scale

McDaniel offers from inventory many dual scale ranges. These include psi/kPA with the psi scale primary and kPA secondary; psi/Bar with the psi scale primary and Bar secondary.

McDaniel offers more ranges and special calibrations than any other manufacturer of gauges - for only a nominal charge, if any. Consult your McDaniel distributor.

## Special Configuration Adder Codes

**B** = psi/bar (dual scale)

**K** = psi/kPa (dual scale)

**O** = O<sub>2</sub> (cleaned for oxygen service).

**N** = Non-standard internals (316 SS tube/tip/socket)  
Models: L, M, N, P, Y, Z

**T** = Test Gauge (Y & Z)

**7/16SAE** = 7/16-20 SAE straight thread with O-ring

## How to Order By Code

1. Select the **model**.
2. Select the **pressure range** (describe if requesting inches of water, mercury, etc.)
3. Specify **mounting style code**, if other than standard bottom connection.
4. Add **special configurations**, if needed - either by code or written description.
5. Add choice of filling, if appropriate. (**GF** = Glycerin Filled, **SF** = Silicone Filled, or **FF** = Fluorolube Filled)

### Example:

Model	Range Code	Mounting Style	Special Configuration	Type of Filling
N	J	U	-	GF

**Order:** A 4" Polyamid "B" gauge with 1/4" NPT connection, range of 800 psi, with panel mount/lower back u-clamp configuration, filled at the factory with glycerin (NJU-GF)

## Last Word

McDaniel 4" and 6" gauges with brass internals are also available in 304 SS cases on request (Inches of H<sub>2</sub>O ranges: standard case is 304 SS). Options include maximum pressure pointers, hi/low adjustable electric contact gauges, special service gauges, diaphragm seals, pulsation snubbers, test gauges and more. Consult your McDaniel distributor. For all stainless gauges, see McDaniel blue brochure, AS 403, or latest revision.



# Dimensional Data

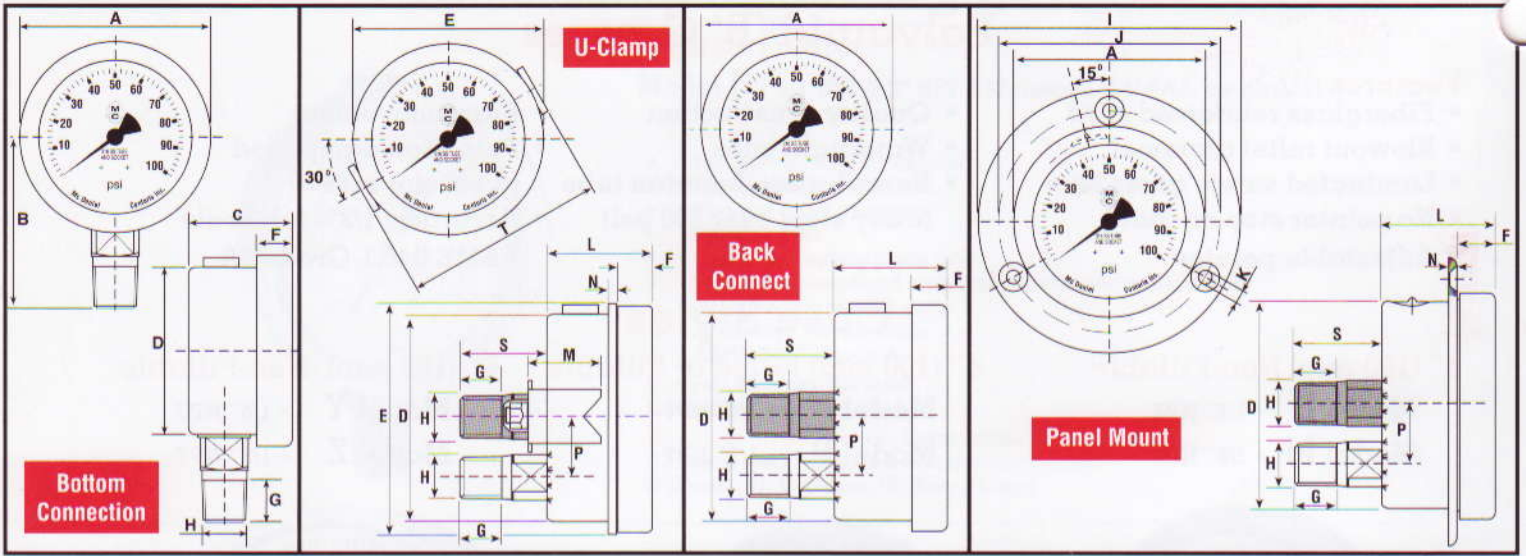

Model	Nominal Size	Case Diameter	A	B	C	D	E	F	G	H	I	J	K	L	M	N	P	S	T
J	2 1/2"	MM In.	68.5 2.70	57 2.24	31 1.22	62 2.44	67 2.64	12 0.47	15 0.59	14 0.55	85 3.35	75 2.95	3.8 0.15	37 1.46	31 1.22	3 0.12	18 0.71	25.5 1.00	67.5 2.66
U	2 1/2"	MM In.	64 2.52	54 2.13	31 1.22	63 2.48	75 2.95	11.5 0.39	14 0.55	14 0.55	NA NA	NA NA	NA NA	30 1.18	25 0.98	3 0.12	CB	22 0.87	71 2.80
L, M, N, P	4"	MM In.	113 4.45	83 3.27	49 1.93	100 3.94	111 4.37	16 0.63	21.5 <sup>(1)</sup> 0.85	22 0.87	NA NA	NA NA	NA NA	49 1.93	39 1.54	1.3 0.06	34 1.33	34 1.34	107 4.21
Y, Z	6"	MM In.	160 6.30	118 4.65	50 1.97	160 6.30	165.5 6.49	21 0.83	21 0.79	22 0.87	196 7.72	178 7.01	5.8 0.23	56 2.20	38 1.50	2 0.08	50 1.97	36 <sup>(2)</sup> 1.42	-

NA = Not Available  
CB = Center-Back connection only

(1) Inches of H2O ranges are Center-Back  
(2) 1/4" NPT = 11 MM (0.43 Inches)  
(3) 1/4" NPT = 15 MM (0.59 Inches)

(4) 1/4" NPT = 32 MM (1.26 Inches)

 Model U is Center-Back. Also, = inches of water ranges are Center-Back: Models J, L, & M.

McDaniel also makes gauges in other materials, in sizes and ranges to fit a wide variety of applications, and in many special configurations.

Ask your representative about McDaniel gauges with stainless steel internals, test gauges, or other requirements.

## DISTRIBUTED BY

P. O. Box 187, Luling, LA 70070 U.S.A. • 14148 Highway 90, Boutte, LA 70039 U.S.A.  
(985) 758-2782 • New Orleans (504) 467-1333 • Fax (985) 758-1688  
www.mcdanielcontrols.com

# McDaniel Controls, Inc.